

Fittings NPCK



Fittings NPCK

Key features

FESTO

Application



Effortless selection of the right fitting. Festo offers a secure solution for every connection. The convenient push-in fitting system includes well over 1000 types of standard and function fittings.

Summary of tubing/fitting combinations

Applications	Fitting	Tubing	Description
Standard	QS	PEN	Suitable for a wide range of tasks and attractively priced. Flexible thanks to high levels of resistance, easy to install thanks to optimised bending radii. High level of abrasion resistance in dynamic applications.
	QS	PUN	Maximum flexibility in standard applications thanks to an extremely wide range of options for combining the different types.
	QS	PAN	Meets all requirements, even for standard applications with increased pressure and temperature ranges.
High pressures	NPQM	PAN-MF	Meets DIN standard 73378: ideal for use in mobile pneumatics. Suitable for increased temperature ranges combined with high pressure ranges.
	NPQH	PAN-R	Powerful in pressure ranges up to 20 bar, for example in applications with the pressure booster DPA.
Resistant to chemicals, food safe and hydrolysis resistant	NPQP	PLN	Resistant to cleaning agents, FDA compliant and economical. Can be used instead of the combination with stainless steel fittings.
	NPKA	PUN-H	Hydrolysis resistant and suitable for water applications. Combination suitable for use in clean rooms, FDA compliant and corrosion resistant as it is made of 100% polymer. Very easy to install thanks to the "one click principle".
	NPQH	PFAN/PTFEN	For high temperatures up to 150 °C. Food safe, FDA compliant and resistant to cleaning agents.
	NPCK	PFAN/PTFEN	Easy to clean thanks to the union nut's edge-free design. Maximum resistance to corrosion (CRC 4) and FDA compliant. Suitable for a wide range of media.
	CRQS	PFAN/PTFEN	Maximum resistance to corrosion (CRC 4) and to aggressive acids and alkalis.
Resistant to chemicals and hydrolysis resistant	NPQR	PFAN/PTFEN	Optimised design, reduction in edges where dirt can collect – all at an attractive price. For high temperatures up to 150 °C. Pressure range up to 16 bar. Highest level of corrosion resistance (CRC 4).
Antistatic	NPQM	PUN-CM	Antistatic tubing plus solid metal fitting: maximum protection for electric and electronic components.
Flame retardant	NPQM	PUN-V0	Very safe in areas where there is a risk of fire thanks to flame-retardant properties. The tubing has been tested to DIN 5510-2.
Resistant to welding spatter	NPQH	PUN-V0-C	Ideal for applications involving welding spatter. Reliable thanks to a tubing wall thickness of 2 mm for all diameters.
	QS-V0	PAN-V0	Safe even in the close vicinity of welding spatter thanks to the double-walled tubing with special fitting.

Fittings NPCK

Key features

FESTO

Push-in fittings product range

QSM, mini series



Technical data → Internet: qsm

Miniature push-in fittings for maximum component density in confined spaces. For pneumatic applications with a temperature range up to 80 °C and a pressure range up to 14 bar. Tubing outside diameters of 2, 3, 4 and 6 mm with connecting threads M3, M5, M6, M7, R $\frac{1}{8}$ and G $\frac{1}{8}$.

QS, standard series



Technical data → Internet: qs

Wide selection of push-in fittings for pneumatic applications with a temperature range up to 80 °C and a pressure range up to 14 bar. Tubing outside diameters of 4, 6, 8, 10, 12, 16 and 22 mm with connecting threads R $\frac{1}{8}$... R $\frac{1}{2}$ and G $\frac{1}{8}$... G $\frac{3}{4}$.

CRQS, stainless steel



Technical data → Internet: crqs

Stainless steel push-in fitting. High corrosion resistance CRC 4 and chemical resistance with approval for use in the food and packaging industry. For pneumatic applications with a temperature range up to 120 °C and a pressure range up to 10 bar. Tubing outside diameters of 4, 6, 8, 10, 12 and 16 mm with connecting threads M5 and R $\frac{1}{8}$... R $\frac{1}{2}$.

QS-V0, resistant to welding spatter



Technical data → Internet: qs-v0

Flame-retardant push-in fitting for use in all areas where there is a risk of fire, for example welding systems in the automotive industry and in the construction industry. For pneumatic applications with a temperature range up to 60 °C and a pressure range up to 10 bar. Tubing outside diameters of 4, 6, 8, 10 and 12 mm with connecting threads R $\frac{1}{8}$... R $\frac{1}{2}$ and G $\frac{1}{8}$... G $\frac{1}{2}$.

NPQH



Technical data → Internet: npqh

Solid metal push-in fitting made of chemically nickel-plated brass. High corrosion resistance CRC 3 and chemical resistance. For pneumatic applications with a temperature range up to 150 °C and a pressure range up to 20 bar. Tubing outside diameters of 4, 6, 8, 10, 12 and 14 mm with connecting threads M5, M7 and G $\frac{1}{8}$... G $\frac{1}{2}$.

NPQM



Technical data → Internet: npqm

Attractively priced metal push-in fitting for pneumatic applications with a temperature range up to 70 °C and a pressure range up to 16 bar. Tubing outside diameters of 3, 4, 6, 8, 10, 12 and 14 mm with connecting threads M5, M7 and G $\frac{1}{8}$... G $\frac{1}{2}$.

NPQP



Technical data → Internet: npqp

Polypropylene fitting for use in applications with extreme influence of media. For pneumatic applications with a temperature range up to 60 °C and a pressure range up to 10 bar. Tubing outside diameters of 4, 6, 8, 10 and 12 mm with connecting threads R $\frac{1}{8}$... R $\frac{1}{2}$.

NPQR, stainless steel



Technical data → Internet: npqr

Stainless steel push-in fitting. Maximum corrosion resistance CRC 4 and chemical resistance. For pneumatic applications with a temperature range up to 150 °C and a pressure range up to 16 bar. Tubing outside diameters of 4, 6, 8, 10 and 12 mm with connecting threads M5, M7 and G $\frac{1}{8}$... G $\frac{1}{2}$.

Fittings NPCK

Key features

FESTO

Functional push-in fittings product range

QSK, self-sealing push-in fitting

Technical data → Internet: qsk



Push-in fitting that blocks the air flow after the tubing is disconnected. For pneumatic applications with a temperature range up to 60 °C and a pressure range up to 14 bar. Tubing O.D.∅ of 4, 6, 8, 10 and 12 mm with connecting threads M5, R1/8 ... R1/2 and G1/8 ... G1/2.

QSR, rotary push-in fitting

Technical data → Internet: qsr



Push-in fitting with swivel connection, rotatable by 360°. The ball bearing enables rotating movements in the application up to max. 500 rpm. For pneumatic applications with a temperature range up to 60 °C and a pressure range up to 14 bar. Tubing O.D.∅ of 4, 6, 8, 10 and 12 mm with connecting threads M5, R1/8 ... R1/2 and G1/8 ... G1/2.

Quick connectors product range

NPCK

Technical data → Internet: npck



Stainless steel fitting for use in areas subject to intensive cleaning. Highest level of corrosion resistance (CRC 4). For pneumatic applications with a temperature range up to 120 °C and a pressure range up to 12 bar. Tubing O.D.∅ of 4, 6, 8 and 10 mm with connecting thread M5 and G1/8 ... G3/8.

Click fittings product range

NPKA

Technical data → Internet: npka



Plastic fitting for easy installation with one-hand operation. Hydrolysis resistant, FDA compliant and easy to clean. For pneumatic applications with a temperature range up to 60 °C and a pressure range up to 10 bar. Tubing O.D. 6 mm with connecting thread G1/8.

Fittings NPCK

Type codes

General

The fitting NPCK is safe for use with food and fulfils all of the Clean Design requirements.

The special design for the union nut

avoids edges and areas where contaminations and microorganisms might accumulate.

The NPCK is made entirely of stainless steel and is ideally suited for use in cleaning-intensive areas. NPCK is thus

the ideal addition to Festo's existing range of Clean Design drive and valve terminal products.

Assembly:

- 1) Screw the threaded plug [1] and the sealing ring [2] on to the counterpart and tighten in accordance with the nominal tightening torque.
- 2) Place the plastic tubing [3] through the die union nut [4] on to the nipple of the threaded plug (→ Fig. 1).
- 3) Screw the union nut on to the threaded plug until it is up against the counterpart (→ Fig. 2). The tubing is thus secured and the sealing ring is pressed between the sealing surface, threaded plug, and union nut.

Dismantling:

- 1) Dismantling is completed in reverse order to the assembly.

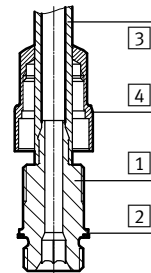

Fig. 1

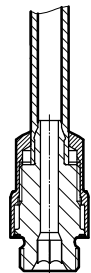

Fig. 2

Type codes

NPCK – C – D – G18 – K6

Type	
NPCK	Fitting

Design	
C	Clean Design

Design	
D	Straight design

Pneumatic connection 1	
M5	Male thread M5
G18	Male thread G $\frac{1}{8}$
G14	Male thread G $\frac{1}{4}$
G38	Male thread G $\frac{3}{8}$



Pneumatic connection 2	
K4	Clamped terminal connection for tubing O.D. 4 mm
K6	Clamped terminal connection for tubing O.D. 6 mm
K8	Clamped terminal connection for tubing O.D. 8 mm
K10	Clamped terminal connection for tubing O.D. 10 mm

Fittings NPCK

Technical data

FESTO

Fittings NPCK
Straight design

-  - Pressure
-0.95 ... +12 bar
-  - Temperature range
-20 ... +120 °C



General technical data						
Pneumatic connection 1	Male thread					
	M5	G1/8	G1/4	G3/8		
Pneumatic connection 2	For tubing O.D. 4 mm	For tubing O.D. 6 mm	For tubing O.D. 8 mm	For tubing O.D. 8 mm	For tubing O.D. 10 mm	For tubing O.D. 10 mm
Nominal width [mm]	2	2.9	4.9	4.9	6.1	6.2
Mounting position	Any					
Type of seal on threaded plug	O-ring	Sealing ring				
Nominal tightening torque [Nm]	1.5 ±10%	6.5 ±10%	20 ±10%		35 ±10%	
Nominal tightening torque [Nm] MPA-C ¹⁾	-	4 ±10%	7 ±10%		12 ±10%	
Suitable tubings	PAN, PFAN, PEN, PLN, PUN-H, PUN-H-DUO					

1) The nominal tightening torque MPA-C applies to the connector between the fitting NPCK and the valve terminal MPA-C. The union nut for the NPCK must not exceed these values. Plastic tubing PUN-H must be used.

Operating and environmental conditions	
Operating pressure [bar]	-0.95 ... +12
complete temperature range	
Operating medium	Compressed air in accordance with ISO 8573-1:2010 [7:-:-] Water as per manufacturer's declaration ¹⁾
Note on operating/pilot medium	Lubricated operation possible
Ambient temperature [°C]	-20 ... +120 ²⁾
Corrosion resistance class CRC ³⁾	4
Food-safe ¹⁾	See supplementary material information

1) Additional information www.festo.com/sp → Certificates.

2) Alternative: The fitting can be used in the temperature range from -40 ... +60 °C when suitable tubing is used. The maximum permissible operating temperature of the tubing must not be exceeded.

3) Corrosion resistance class CRC 4 to Festo standard FN 940070

Particularly high corrosion stress. Outdoor exposure under extreme corrosive conditions. Parts exposed to aggressive media, for instance in the chemical or food industries. These applications may need to be supported by special tests (→ also FN 940082) using appropriate media.

Materials						
Pneumatic connection 1	Male thread					
	M5	G1/8	G1/4	G3/8		
Pneumatic connection 2	For tubing O.D. 4 mm	For tubing O.D. 6 mm	For tubing O.D. 8 mm	For tubing O.D. 8 mm	For tubing O.D. 10 mm	For tubing O.D. 10 mm
Housing	High-alloy stainless steel					
Threaded plug	High-alloy stainless steel					
Sealing ring	EPDM	PEEK				
Note on materials	RoHS-compliant					
	-			Contains PWIS (paint wetting impairment substances)		

Fittings NPCK

Technical data

Dimensions

Download CAD data → www.festo.com

Male thread M5

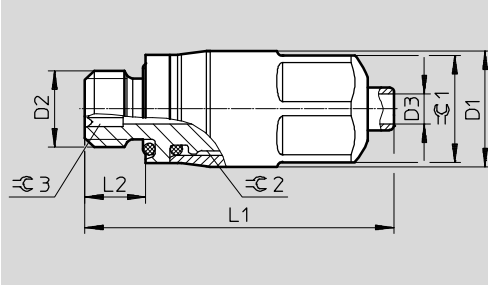

Male thread G...

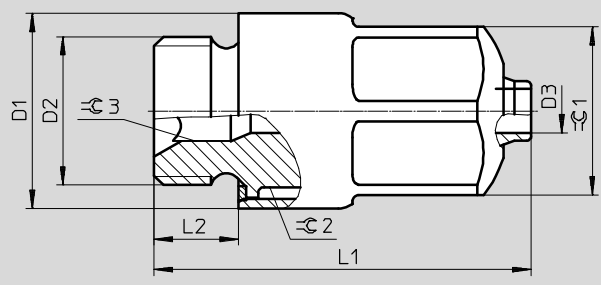

Ordering data

Pneumatic connection		D1	D3	L1	L2	⌀C1	⌀C2	⌀C3	Weight [g]	Part No.	Type	PU ¹⁾
Male thread	For tubing O.D. [mm]	∅	∅									
M5	4	7.6	2	20.3	4	7	5.5	2	4.2	1857681	NPCK-C-D-M5-K4	1
G ¹ / ₈	6	12.8	2.9	24.7	5.5	11	10	4	14.1	1366257	NPCK-C-D-G18-K6	1
	8		4.9					5	13.4	1490383	NPCK-C-D-G18-K8	1
G ¹ / ₄	8	17.9	4.9	28.1	6.4	15	14	6	28.85	1691701	NPCK-C-D-G14-K8	1
	10		6.1	30.4				6	32.9	1489336	NPCK-C-D-G14-K10	1
G ³ / ₈	10	21.8	6.2	33.7	7.4	19	18	6	51.15	1489614	NPCK-C-D-G38-K10	1

1) Packaging unit quantity

Fittings NPCK

Accessories

FESTO

Sealing ring NPAS

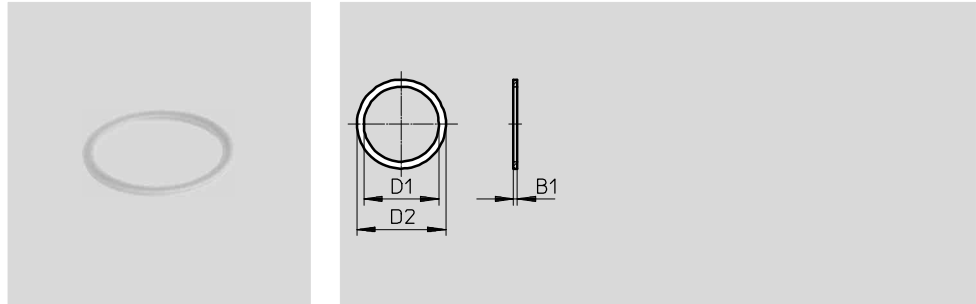

General technical data			
Pneumatic connection 1	Male thread G1/8	Male thread G1/4	Male thread G3/8
Mounting position	Any		
Nominal tightening torque [Nm]	6.5 ±10%	20 ±10%	35 ±10%

Operating and environmental conditions	
Ambient temperature [°C]	-20 ... +120
Corrosion resistance class CRC ¹⁾	4
Food-safe ²⁾	See supplementary material information

- 1) Corrosion resistance class CRC 4 to Festo standard FN 940070
Particularly high corrosion stress. Outdoor exposure under extreme corrosive conditions. Parts exposed to aggressive media, for instance in the chemical or food industries. These applications may need to be supported by special tests (→ also FN 940082) using appropriate media.
- 2) Additional information www.festo.com/sp → Certificates.

Materials	
Sealing ring	PEEK
Note on materials	RoHS-compliant

Dimensions and ordering data							
Pneumatic connection	B1	D1	D2	Weight/piece [g]	Part No.	Type	PU ¹⁾
Male thread G1/8	0.5	9.9	11.7	0.02	2652516	NPAS-C1-R-G18-P-FD-P10	10
Male thread G1/4	0.5	13.3	16.6	0.05	2652517	NPAS-C1-R-G14-P-FD-P10	10
Male thread G3/8	1	16.8	20.7	0.15	2652519	NPAS-C1-R-G38-P-FD-P10	10

- 1) Packaging unit quantity

Festo - Your Partner in Automation



1 Festo Inc.
5300 Explorer Drive
Mississauga, ON L4W 5G4
Canada

Festo Customer Interaction Center
Tel: 1 877 463 3786
Fax: 1 877 393 3786
Email: customer.service.ca@festo.com

2 Festo Pneumatic
Av. Ceylán 3,
Col. Tequesquináhuac
54020 Tlalneantla,
Estado de México

Multinational Contact Center
01 800 337 8669
ventas.mexico@festo.com

3 Festo Corporation
1377 Motor Parkway
Suite 310
Islandia, NY 11749

Festo Customer Interaction Center
1 800 993 3786
1 800 963 3786
customer.service.us@festo.com

4 Regional Service Center
7777 Columbia Road
Mason, OH 45040

Connect with us



www.festo.com/socialmedia



www.festo.com

Subject to change